

T 7040 EN

Type 3433 Pneumatic Controller Module

Series 430

Application

Controller modules for installation in Type 3430 Pneumatic Indicating Controllers

The Type 3433 Controller Modules are designed for input and output signals of 0.2 to 1.0 bar and for a supply pressure of 1.4 bar.

The connectors of the controller modules are plugged into the self-sealing sockets of the controller station and held by a fastening screw.

Versions

The controller modules have a comparing element that operates according to the motion-balance method with four metal bellows arranged in a square and stabilized by springs.

Type 3433-2 (Fig. 1) · Controller module for PI control action

Type 3433-3 (Fig. 2) · Controller module for PID control action

The proportional-action coefficient K_p , reset time T_n , direction of action and the controller zero are adjustable in the PI controller module. The derivative-action time T_v can also be adjusted in the PID controller module.

Refer to Data Sheet ▶ T 7041 for information on a further controller module for PI control action

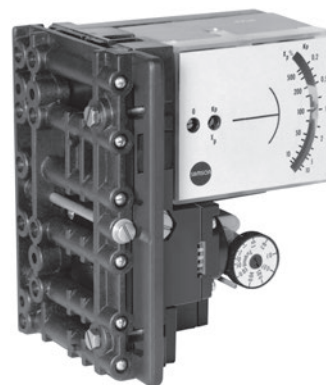

Fig. 1: Type 3433-2 PI Controller Module

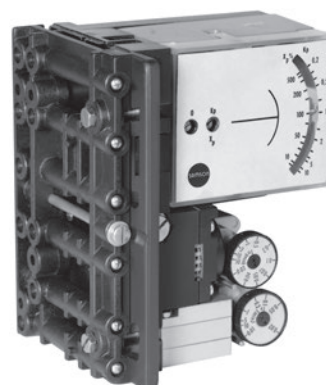

Fig. 2: Type 3433-3 PID Controller Module

Principle of operation of controller modules

Type 3433-2 PI Controller Module (Fig. 3 and Fig. 4)

The controlled variable x and the reference variable w are transferred as gauge pressures between 0.2 and 1 bar/3 to 15 psi over turnboard A to the metal bellows (5) and (7). When x exceeds w , the controlled variable bellows (7) tilts the taut-band-suspended washplate (1) around the pivot (2) towards the set point bellows (5). As a result, the nozzle (9) comes closer to the flapper plate (10). The pressure in the nozzle increases, causing the signal pressure Y_A produced by the booster (16) to increase, which is fed back without delay to the bellows R2 (8) over the turnboard B and with delay to the bellows R1 (6) through the external connection R and the T_n restrictor (18). The position of the washplate and the output pressure y_A keep changing until the distance between nozzle and flapper reaches the output value and the output pressure y_A assumes a value corresponding to the controlled variable x and the adjusted proportional-action coefficient K_p (i.e. until the system deviation is eliminated).

The proportional-action coefficient is adjusted at the screw (14), while the reset time T_n is adjusted at the restrictor (18). Zero adjustment is used to calibrate the controller module.

Fig. 4 shows the schematic drawing of the Type 3433-2 PI Controller Module. The direction of action, i.e. the output pressure increases or decreases when the controlled variable increases, is selected at the turnboard A.

Whenever a switching pressure is applied to the connection S in the manual mode, the T_n start-up relay (19) switches to open the bypass to the T_n restrictor (18), causing a uniform pressure distribution to the bellows R1 and R2.

In the delivered state, the turnboard B is adjusted to y_A , i.e. the signal pressure y_A is fed back directly to the bellows R2, and to the bellows R2 through the connection R. In this arrangement, the controller provides standard air delivery and output pressure damping. As a result, the function to supply additional air volume usually needed under extraordinary service conditions (such as especially short signal transmission and small connected air volume) does not come into force. Switching the turnboard B to position R is useful for a large connected air volume, for fast control loops, and if the control signal must cover a long transmission distance. In this arrangement, the signal pressure y_A is fed back to the bellows R1 and R2 through the connection R. This ensures that the controller has a good air delivery characteristic for these applications.

Type 3433-3 PID Controller Module (Fig. 5)

The PID controller module largely corresponds to the Type 3433-2 PI Controller Module. This module, however, contains an additional derivative element providing a rate gain of the input branch of the controlled variable x . In steady state, the output signal of the derivative element D1 equals the input signal x . When the input signal x changes, the derivative-action element D1 amplifies the signal change by about ten times corresponding to the derivative-action gain. This amplification is reduced to the ratio 1:1 as a function of the derivative-action time adjusted on the T_v restrictor. The T_v start-up relay D2 bypasses the T_v restrictor when a switching pressure is applied to the input.

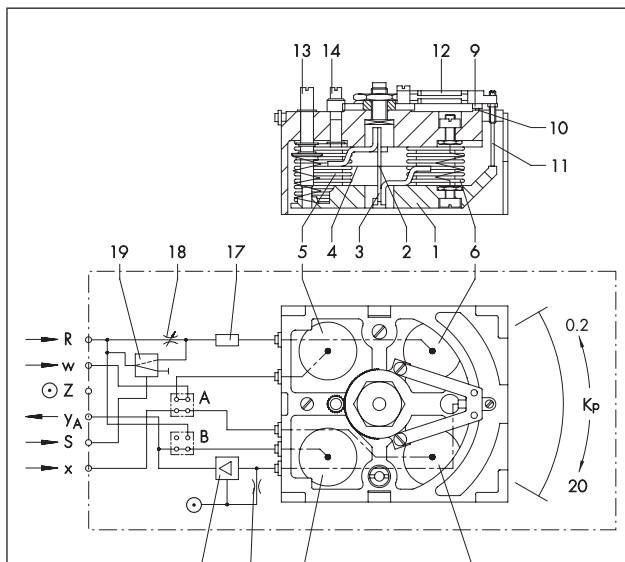

Fig. 3: Schematic drawing of Type 3433-2 PI Controller Module

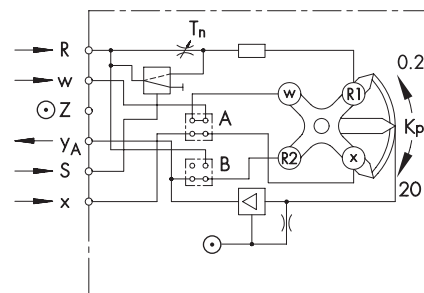

Fig. 4: Type 3433-2 PI Controller Module

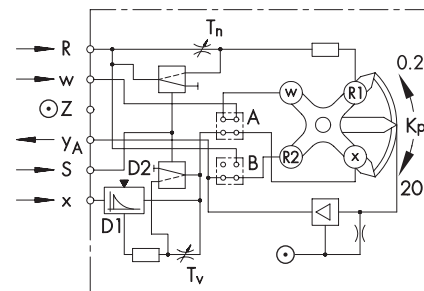

Fig. 5: Type 3433-3 PID Controller Module

Legend for Fig. 3 to Fig. 5

w	Reference variable (set point)	10	Flapper plate
x	Controlled variable	A	Turnboard for direction of action
y_A	Output signal pressure	B	Turnboard for feedback function
R	Feedback for bellows R1		
S	Switching pressure		
1	Swashplate	11	Pin
2	Fulcrum	12	Spring bearings
3	Pin (suspension)	13	Zero adjustment
4	Taut band (suspension)	14	Adjuster for K_p
5	Set point bellows w	15	Restrictor
6	Feedback bellows R1	16	Booster
7	Controlled variable bellows x	17	Volume
8	Feedback bellows R2	18	T_n restrictor
9	Nozzle	19	T_n start-up relay







Symbols for schematic diagrams			
	Supply air		Turnboard
	Fixed restrictor		Adjuster
	Adjustable restrictor		Start-up relay
	Booster		

Fig. 6: Symbols for schematic diagrams

Table 1: Technical data · All pressure stated as gauge pressure in bar

Controller module	Type 3433-2	Type 3433-3
Controller action	PI	PID
Control parameters	Proportional-action coefficient $K_p = 0.2$ to 20 Reset time $T_n = 0.03$ to 50 min. Derivative-action time $T_v = 0.01$ to 10 min Derivative-action gain of $x: \approx 10$	
Input	0.2 to 1.0 bar	
Output	0.2 to 1.0 bar · Max. 0.02 to 1.35 bar Max. air output capacity: $> 1.5 \text{ m}_n^3/\text{h}$ Air output capacity when adjusted to 'y _A ': approx. $1 \text{ m}_n^3/\text{h}$ per % of the system deviation Air output capacity when adjusted to 'R': approx. $3 \text{ m}_n^3/\text{h}$ per % of the system deviation	
Supply air	1.4 bar supply air	
Air consumption in steady state	< 0.05	< 0.13
Alignment offset	< 0.5 %	
Tracking error	< 0.5 %	
Dead band	< 0.01 %	
Derivative element	Deviation of controlled variable $x: < 1 \%$	
Effect of supply air at 1.4 ± 0.1 bar	$< \pm 0.1 \%$ (D element additionally: $< \pm 0.2 \%$)	
Effect of temperature/°C	$< \pm 0.01 \%$ (D element additionally: $< \pm 0.01 \%$)	
Permissible ambient temperature range	-20 to 60 °C	
Weight, approx.	0.7 kg	

Ordering text

Type 3433-... Controller Module

