

MOUNTING AND OPERATING INSTRUCTIONS



EB 9511 EN

Translation of original instructions



SAM Connect Gateway (Type 5007-2)

Firmware version 1.03.11



Edition January 2021

Note on these mounting and operating instructions

These mounting and operating instructions assist you in mounting and operating the device safely. The instructions are binding for handling SAMSON devices. The images shown in these instructions are for illustration purposes only. The actual product may vary.

- For the safe and proper use of these instructions, read them carefully and keep them for later reference.
- If you have any questions about these instructions, contact SAMSON's After-sales Service (aftersaleservice@samsongroup.com).



Documents relating to the device, such as the mounting and operating instructions, are available on our website at www.samsongroup.com > **Service & Support > Downloads > Documentation.**

Definition of signal words

DANGER

Hazardous situations which, if not avoided, will result in death or serious injury

WARNING

Hazardous situations which, if not avoided, could result in death or serious injury

NOTICE

Property damage message or malfunction

Note

Additional information

Tip

Recommended action

1	Safety instructions and measures	1-1
1.1	Notes on possible property damage	1-3
2	Markings on the device	2-1
2.1	Nameplate	2-1
2.2	Firmware versions	2-2
2.3	Article code	2-3
3	Design and principle of operation	3-1
3.1	Configuration using the TROVIS-VIEW software	3-4
3.2	Versions	3-4
3.3	Device overview and operating controls	3-4
3.4	Option modules	3-6
3.5	Power supply unit with standby power supply (SPS)	3-6
3.6	Technical data	3-7
3.7	Dimensions in mm	3-10
3.7.1	Dimensions for mounting (mm)	3-11
4	Shipment and on-site transport	4-1
4.1	Accepting the delivered goods	4-1
4.2	Removing the packaging from the SAM Connect Gateway and modules	4-1
4.3	Transporting the SAM Connect Gateway	4-1
4.4	Storing the gateway	4-1
5	Installation	5-1
5.1	Installation conditions	5-1
5.2	Preparation for installation	5-1
5.3	Setting up the optional additional functions	5-1
5.3.1	Inserting option modules	5-2
5.3.2	Setting up the standby power supply (SPS)	5-4
5.4	Mounting the SAM Connect Gateway	5-6
5.5	Establishing electrical connections	5-6
6	Operation	6-1
6.1	Capacitive keys	6-1
6.2	Display	6-2
7	Start-up and configuration	7-1
7.1	Settings	7-2
7.1.1	Setting the user level	7-2
7.1.2	Setting the language	7-3
7.1.3	Activating password protection	7-3

Contents

7.1.4	Setting the local power line frequency.....	7-4
7.1.5	Performing option module settings.....	7-4
8	Operation	8-1
8.1	Remote data transmission	8-1
8.1.1	Status LEDs of the GSM module.....	8-1
8.1.2	Improving the signal quality.....	8-1
9	Malfunctions	9-1
9.1	Troubleshooting	9-1
10	Servicing.....	10-1
10.1	Firmware updates	10-1
10.2	Periodic inspection and testing of the gateway.....	10-1
11	Decommissioning	11-1
12	Removal	12-1
12.1	Removing the option module.....	12-1
12.2	Removing the gateway	12-1
13	Repairs	13-1
13.1	Returning devices to SAMSON	13-1
14	Disposal.....	14-1
15	Certificates.....	15-1
16	Annex A (configuration instructions).....	16-1
17	Annex B.....	17-1
17.1	Accessories	17-1
17.2	After-sales service	17-1

1 Safety instructions and measures

Intended use

The modular SAM Connect Gateway allows the input of signals (4 to 20 mA), for example issued by external transmitters. Furthermore, the integrated GSM module allows remote data transmission.

The device is designed to operate under exactly defined conditions (e.g. supply voltage, temperature). Therefore, operators must ensure that the device is only used in operating conditions that meet the specifications used for sizing the device at the ordering stage.

SAMSON does not assume any liability for damage resulting from the failure to use the device for its intended purpose or for damage caused by external forces or any other external factors.

→ Refer to the technical data for limits and fields of application as well as possible uses.

Reasonably foreseeable misuse

The SAM Connect Gateway is **not** suitable for the following applications:

- Use outside the limits defined during sizing and by the technical data

Furthermore, the following activities do not comply with the intended use:

- Use of non-original spare parts
- Performing maintenance activities not described in these instructions

Qualifications of operating personnel

The device must be mounted, started up and serviced by fully trained and qualified personnel only; the accepted industry codes and practices are to be observed. According to these mounting and operating instructions, trained personnel refers to individuals who are able to judge the work they are assigned to and recognize possible hazards due to their specialized training, their knowledge and experience as well as their knowledge of the applicable standards.

Personal protective equipment

No personal protective equipment is required for the direct handling of the SAM Connect Gateway. Work in the plant may be necessary that requires personal protective equipment.

→ Check with the plant operator for details on personal protective equipment.

Safety instructions and measures

Revisions and other modifications

Revisions, conversions or other modifications of the product are not authorized by SAMSON. They are performed at the user's own risk and may lead to safety hazards, for example. Furthermore, the product may no longer meet the requirements for its intended use. Use of the device is no longer permitted in this case.

Warning against residual hazards

To avoid personal injury or property damage, operators and operating personnel must prevent hazards that could be caused in the device by taking appropriate precautions. Plant operators and operating personnel must observe all hazard statements, warning and caution notes in these mounting and operating instructions, especially for installation, start-up and service work.

Responsibilities of the operator

Operators are responsible for proper use and compliance with the safety regulations. Operators are obliged to provide these mounting and operating instructions to the operating personnel and to instruct them in proper operation. Furthermore, operators must ensure that operating personnel or third parties are not exposed to any danger.

Responsibilities of operating personnel

Operating personnel must read and understand these mounting and operating instructions as well as the specified hazard statements, warning and caution notes. Furthermore, the operating personnel must be familiar with the applicable health, safety and accident prevention regulations and comply with them.

Referenced standards, directives and regulations

Devices with a CE marking fulfill the requirements of the Directives 2014/53/EU and 2011/65/EU.

The 'Certificates' section contains this declaration of conformity.

Referenced documentation

The following documents apply in addition to these mounting and operating instructions:

- Operating Instructions (SAM Connect Gateway – Configuration with TROVIS-VIEW)
▶ EB 9511-2
- Mounting and operating instructions for connected components (Media 5, Media 6)

1.1 Notes on possible property damage

! NOTICE

Risk of fatal injury due to electric shock (230 V version).

- Before connecting wiring, performing any work on the device or opening the device, disconnect the voltage supply and protect it against unintentional reconnection.
- Only use power interruption devices that are protected against unintentional reconnection of the power supply.

Risk of damage to the electronics due to the incorrect connection of the electrical power supply.

The SAM Connect Gateway is designed to operate under exactly defined electrical conditions.

- Observe the permissible tolerances of the supply voltage.
- For wiring, you are required to observe the relevant regulations concerning device safety and electromagnetic compatibility.

Risk of damage to the device due to incorrect mounting position.

- Mount the device in the upright position only.

Incorrect installation and removal of option modules will damage the SAM Connect Gateway.

- Before inserting or removing the option modules, disconnect the supply voltage.

Risk of malfunction due to incorrect power line frequency setting.

The local power line frequency must be entered to be able to properly filter out any disturbances which are transmitted over ground wires or external power supply units.

- Set the local power line frequency by selecting the corresponding parameters.

The use of unapproved batteries will damage the SAM Connect Gateway.

- Do not use rechargeable batteries in the SAM Connect Gateway.

Risk of device damage due to foreign particles entering it.

- Do not remove the packaging and protective film/protective caps until immediately before mounting and start-up.

2 Markings on the device

2.1 Nameplate

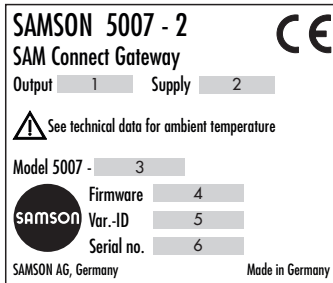

- 1 Signal range
- 2 Electric power supply
- 3 Model number
- 4 Firmware version
- 5 Configuration ID
- 6 Serial number¹⁾

¹⁾ The first two figures of the serial number in reverse order indicate the year of manufacture (example: serial number 71xxxxx → Year of manufacture = 2017).

Option module:



- 1 Abbreviation of optional additional function
- 2 Optional additional function

GSM module:

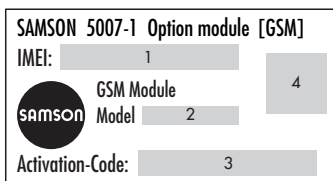

- 1 International Mobile Equipment Identity¹⁾
- 2 Model number
- 3 Activation code
- 4 QR code

²⁾ 15-digit serial number for unique identification of mobile devices

2.2 Firmware versions

Firmware revisions	
Old	New
1.02.07	1.03.09
	<ul style="list-style-type: none">• New version: 230 V version• Increased measuring accuracy of the analog inputs• Russian and Turkish added as menu and display language• Start-up wizard added• Improved operation• Four-figure code to protect the gateway settings
1.03.09	1.03.11
	Internal revisions

2.3 Article code

SAM Connect Gateway	5007-2- 0 0 0	x	x	x	x	x	x	0	x	0	0	0	x	x	x	x	x
Power supply																	
Power supply unit, 18 to 36 V DC	1																
Power supply unit, 100 to 230 V AC	2																
Option module slot 1																	
AI: Analog input	4																
AIA: Analog input active	6																
Option module slot 2																	
Without	0																
AI: Analog input	4																
AIA: Analog input active	6																
Option module slot 3																	
Without	0																
AI: Analog input	4																
AIA: Analog input active	6																
Option module slot 4																	
Without	0																
AI: Analog input	4																
AIA: Analog input active	6																
GSM module																	
GSM module with antenna (including SIM card)							2										
Housing material																	
Plastic								0									
Version																	
Standard										0	0						
Hardware version																	
Index: 00																9	9

3 Design and principle of operation

The modular SAM Connect Gateway allows the input of signals (4 to 20 mA), for example issued by external transmitters. For this purpose, four slots exist in the device to hold option modules that can optionally be used for the **AI (analog input)** and/or **AIA (analog input active)** option modules.

i Note

At least one option module must always be installed in the SAM Connect Gateway. See section 3.4 for details on the option modules.

Furthermore, the integrated GSM module allows remote data transmission and connection to the SAM TANK MANAGEMENT web portal.

Application

The SAM Connect Gateway can accept up to four 4 to 20 mA signals and transfer the data over the integrated GSM module. As a result, transmitters installed in a plant (e.g. Media 5, Media 6 and/or other transmitters by other manufacturers) can be connected to the SAM TANK MANAGEMENT web interface. This allows the filling levels of up to four tanks (Fig. 3-2) or the filling level and pressure of two tanks (Fig. 3-3) to be logged and managed on the SAM TANK MANAGEMENT interface.

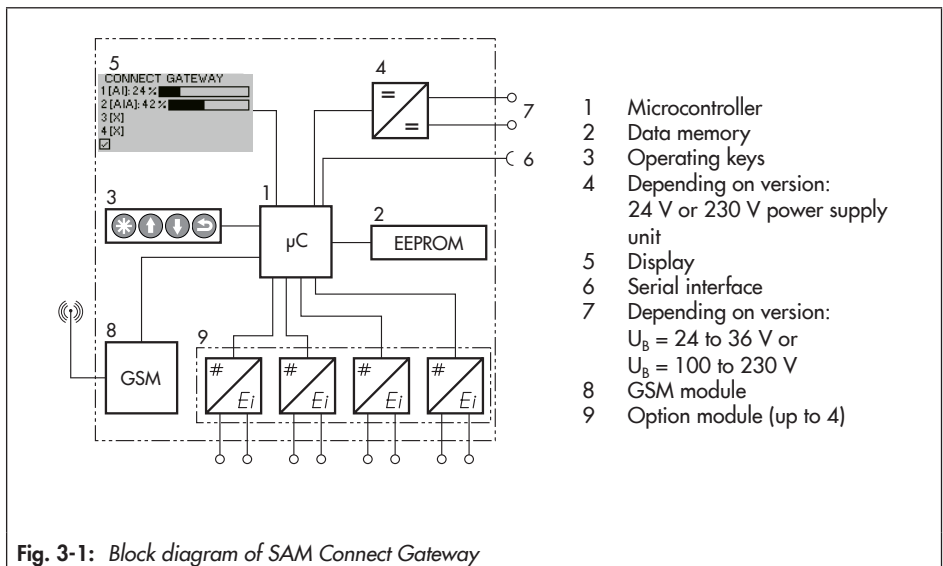

Fig. 3-1: Block diagram of SAM Connect Gateway

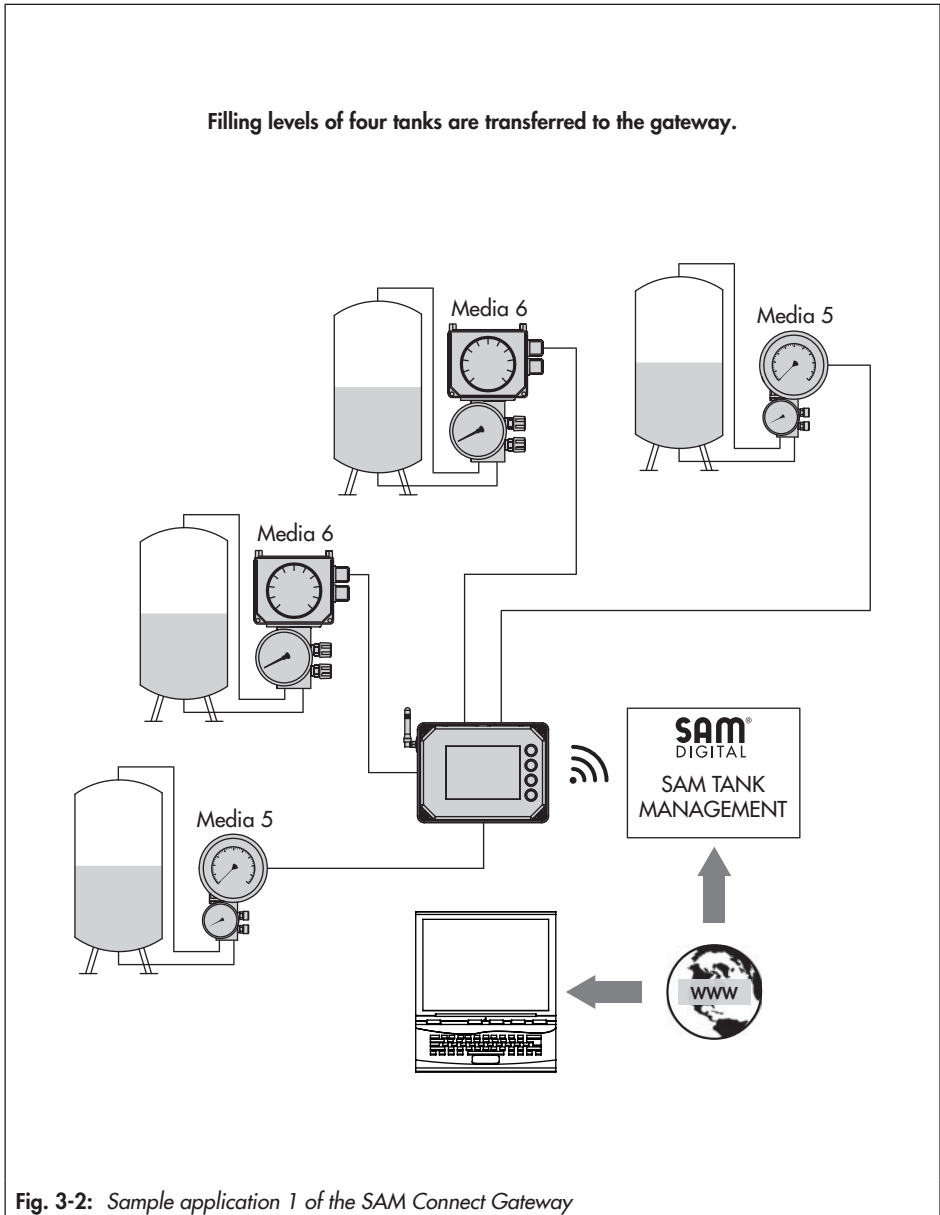

Fig. 3-2: Sample application 1 of the SAM Connect Gateway

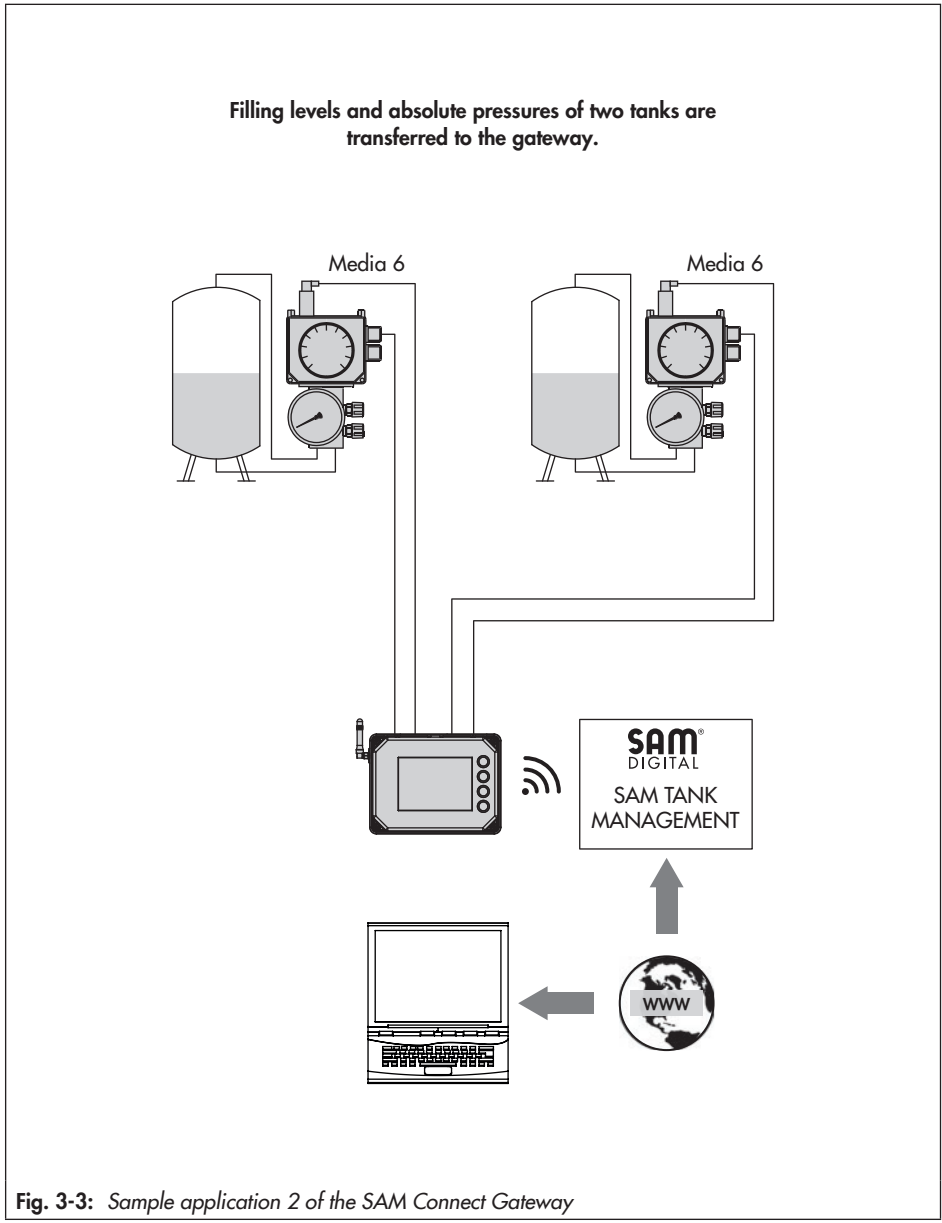

Fig. 3-3: Sample application 2 of the SAM Connect Gateway

Design and principle of operation

Operation

Four capacitive keys are used to operate the SAM Connect Gateway and allow the user to navigate within the menu on the display.

3.1 Configuration using the TROVIS-VIEW software

The SAM Connect Gateway can be configured with SAMSON's TROVIS-VIEW Software (version 4). For this purpose, the gateway has a digital interface (SSP) to allow the USB port of a computer to be connected to it using an adapter cable (order no. 1400-9740).

The TROVIS-VIEW software enables the user to easily configure the gateway as well as view process parameters online.

i Note

TROVIS-VIEW can be downloaded free of charge from our website at www.samsongroup.com > Service & Support > Downloads > TROVIS-VIEW.

3.2 Versions

24 V version (Type 5007-2-0001...)

- Input voltage: 24 to 36 V DC
- Operating temperature: -40 to +70 °C

230 V version (Type 5007-2-0002...)

- Input voltage:
 - 100 to 230 V/50 Hz
 - 100 to 110 V/60 Hz
- Operating temperature: -20 to +70 °C

3.3 Device overview and operating controls

→ See Fig. 3-4

- 1 Display
- 2 Confirm key
- 3 Up arrow key
- 4 Down arrow key
- 5 Back key
- 6 Error LED
- 7 Battery LED (SPS)
- 8 Status LEDs for GSM module
- 9 Terminal to connect the supply voltage
- 10 GSM module
- 11 SSP interface
- 12 Slots 1 to 4 for option modules
- 13 SPS: standby power supply
- 14 Grounding connection

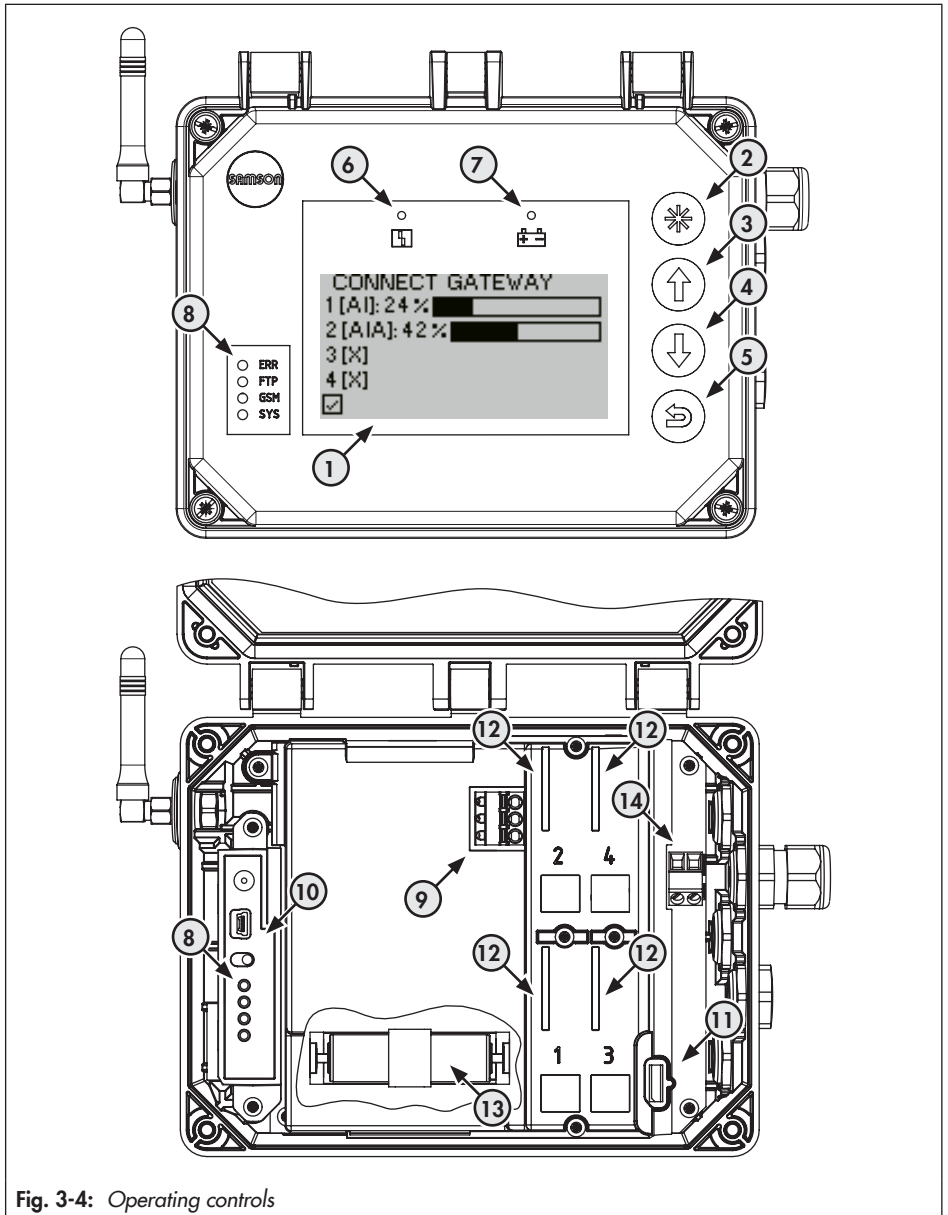

Fig. 3-4: Operating controls

3.4 Option modules

The gateway provides analog inputs through the use of option modules to accept (4 to 20 mA) analog signals from filling level or pressure sensors of external equipment. Four slots are available in the device.

Upon delivery of the SAM Connect Gateway, at least one option module is installed. Further option modules can be retrofitted. The following option modules are available:

- **AI: Analog input**
This module works passively and has galvanically isolated inputs. It can accept signals from devices with their own power supply.
- **AIA: Analog input active**
This **AIA (analog input active)** option module works actively and has a 12 V output to power external equipment that do not have their own power supply.

3.5 Power supply unit with standby power supply (SPS)

The power supply units include a battery compartment for a 1.5 V battery which provides standby power supply upon power failure.

3.6 Technical data

Table 3-1: *General technical data*

SAM Connect Gateway	
Mounting orientation	Upright with display facing sideways
Display	
Display	LCD 128 x 64 (90 x 40 mm)
Storage temperature	-40 to approx. +80 °C
Operating temperature	24 V version: -40 to +70 °C 230 V version: -20 to +70 °C ¹⁾
Environmental influences	
Storage according to EN 60721-3-1 (long-term storage)	1K5 (air temperature -40 to +80 °C); 1M3 (The following restriction applies to GSM module: air temperatures -30 to +75 °C)
Transportation according to EN 60721-3-2	2K4 (air temperature -40 to +40 °C in ventilated enclosures, up to +70 °C in unventilated enclosures), 2M1 (The following restriction applies to GSM module for low air temperatures down to -30 °C)
Operation according to EN 60721-3-4 (stationary use at non-weather-protected locations)	4K4 (with restrictions: air temperature -40 to +55 °C, temperature inside the housing must not exceed +70°C when exposed to direct sunlight); 4M4 The display and GSM module are heated at low air temperatures.
Mechanical vibration	
Vibrations (sinusoidal) according to IEC 60068-2-6	2 to 9 Hz; 3.5 mm amplitude 9 to 200 Hz; 10 m/s ² acceleration 200 to 500 Hz; 15 m/s ² acceleration
Random and guidance vibration according to IEC 60068-2-64	1.0 m ² /s ³ ; 10 to 200 Hz 0.3 m ² /s ³ ; 200 to 2000 Hz
Shocks according to IEC 60068-2-27	Acceleration 100 m/s ² ; duration 11 ms
Requirements	
EMC	Devices with a CE marking fulfill the requirements of the Directive 2014/30/EU. Compliance with EN 61000-6-2, EN 61000-6-3 and EN 61326-1.
Degree of protection	IP 67 according to IEC 60529 (VDE 470 Part 1, 2014-09)
Electrical connections	
Cable glands	M16 x 1.5 (max. 5)
Terminals	0.2 to 2.5 mm ² wire cross-section
Spring-cage terminals (option modules)	0.13 to 1.5 mm ² wire cross-section

Design and principle of operation

Communication	
Local	SAMSON SSP interface and serial interface adapter, TROVIS-VIEW
Remote data transmission	GSM module
Weight	
Device (with 4 option modules)	Approx. 1400 g

- ¹⁾ Impaired operation and readability may arise outside the temperature range.
Measurement is not influenced in the range between -40 and +70 °C.

Table 3-2: Power supply

24 V version	
Input voltage	24 to 36 V DC
Output voltage	12 V DC
Power	24 W
Version	Reverse polarity protection
230 V version	
Input voltage	100 to 230 V/50 Hz · 100 to 110 V/60 Hz
Output voltage	14 V DC
Power	Max. 10 W

Table 3-3: Optional additional functions

AI: Analog input	
Version	4 to 20 mA current input, externally powered, galvanically isolated, reverse polarity protection
Load impedance	≤5.0 V external (corresponding to ≤200 Ω at 20 mA)
Measuring range	0.1 to 21.6 mA
Accuracy	≤1.0 %
Resolution	20 µA
Effect of temperature	0.3 %/10 K
Static destruction limit	38 V DC · 30 V AC
AIA: Analog input active	
Version	4 to 20 mA current input, internally powered, reverse polarity protection
Load impedance	≤1 V internal (corresponds to ≤50 Ω at 20 mA)
Output voltage at the terminal	≥12 VDC to power external two-wire devices
Measuring range	0.1 to 21.6 mA

Accuracy	≤1.0 %
Resolution	20 µA
Effect of temperature	0.3 %/10 K
Static destruction limit	38 V DC · 30 V AC
GSM module for remote data transmission	
GSM frequency	E-GSM 850/900/1800/1900 MHz
Power output	Class 4 (2 W) with 850/900 MHz; Class 1 (1 W) with 1800/1900 MHz
Antenna connection	SMA connector in housing wall
Right-angle antenna	Type 2J010: SMA R/A male
Color	Black
Capacity	25 W
Impedance	50 Ω
Polarization	Vertical
Frequency	GSM (900 MHz), AMPS (824-894 MHz), ISM (868 MHz), DCS (1800 MHz), PCS (1900 MHz), 3G (UMTS 2.1 GHz)
SIM card	M2M Industrial Plug in High Temperature, operating temperature: -40 to +105 °C; Provider: Telefonica Germany GmbH
Operating temperature	-40 to +70 °C (with active heating control)
Storage temperature	-30 to +75 °C
Web interface	SAM TANK MANAGEMENT

Table 3-4: Materials

Housing	UV-stabilized polycarbonate
Screws (housing)	Corrosion-resistant steel
Cover (transparent)	UV-stabilized polycarbonate
Screw fastenings (cover)	Corrosion-resistant steel
Cable glands	Polyamide with NBR seal

3.7 Dimensions in mm

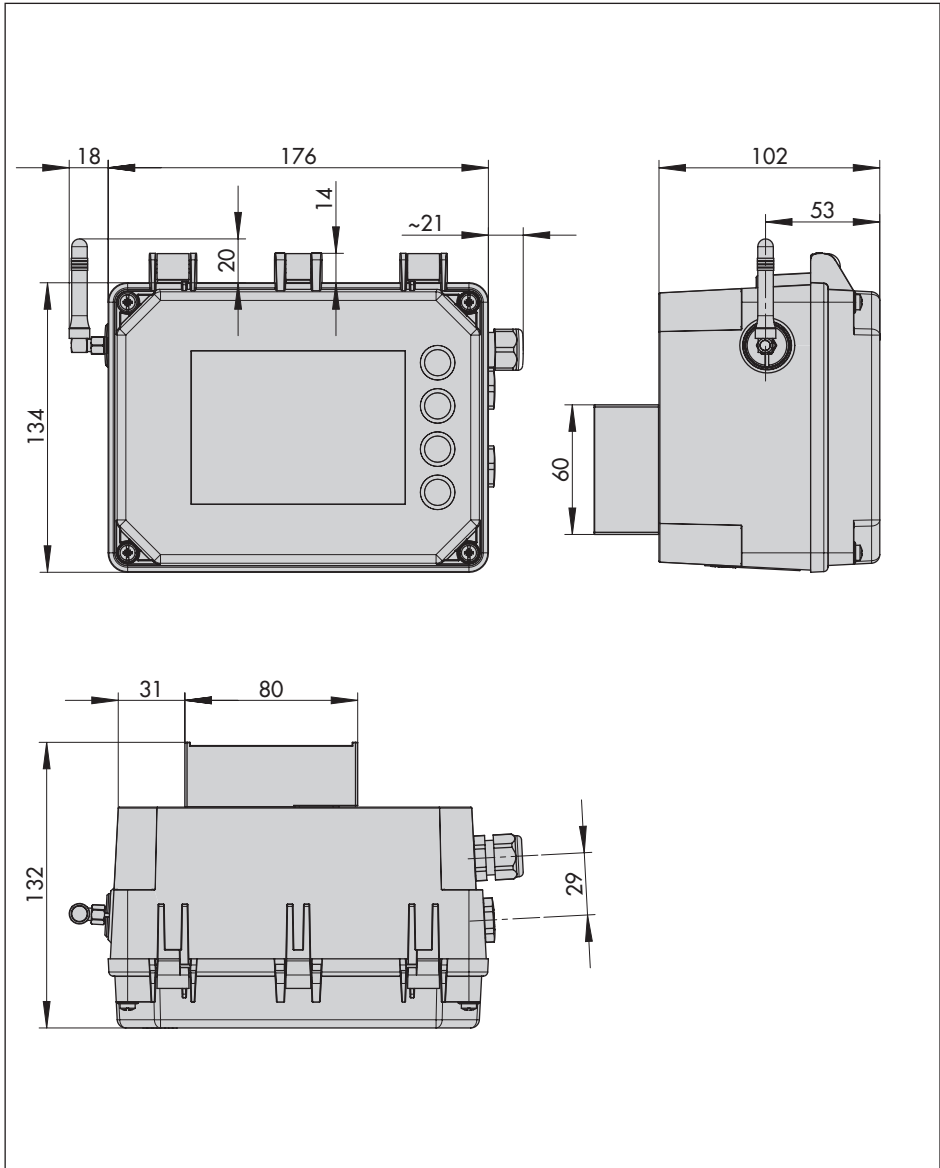

3.7.1 Dimensions for mounting (mm)

Dimensions with opened cover:

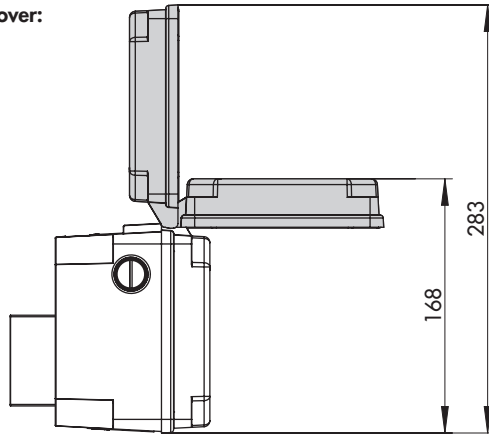

Drill pattern for mounting:

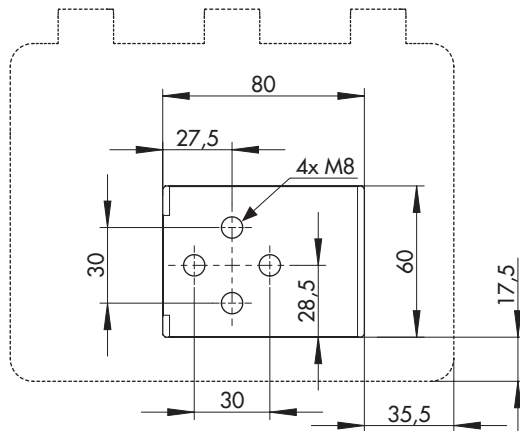

4 Shipment and on-site transport

The work described in this section is only to be performed by personnel appropriately qualified to carry out such tasks.

4.1 Accepting the delivered goods

After receiving the shipment, proceed as follows:

1. Check the scope of delivery. Check that the specifications on the nameplate of the SAM Connect Gateway match the specifications in the delivery note. See the 'Markings on the device' section for nameplate details.
2. Check the shipment for transportation damage. Report any damage to SAMSON and the forwarding agent (refer to delivery note).

4.2 Removing the packaging from the SAM Connect Gateway and modules

Observe the following sequence:

- ➔ Do not remove the packaging until immediately before installation.
- ➔ Dispose and recycle the packaging in accordance with the local regulations.
- ➔ Keep the packaging of the modules for their interim storage.

4.3 Transporting the SAM Connect Gateway

Transport instructions

- Only transport the gateway without any batteries in it.
- Protect the gateway against external influences (e.g. impact).
- Protect the gateway against moisture and dirt.
- Observe the environmental conditions according to EN 60721-3-2:
 - 2K4 for a gateway
 - 2M1 for a gateway with GSM module

4.4 Storing the gateway

NOTICE

Risk of gateway damage due to improper storage.

- ➔ *Observe the storage instructions.*
 - ➔ *Avoid long storage times.*
 - ➔ *Contact SAMSON in case of different storage conditions.*
-

Note

We recommend regularly checking the prevailing storage conditions during long storage periods.

Shipment and on-site transport

Storage instructions

- Protect the gateway against external influences (e.g. impact).
- Protect the gateway against moisture and dirt.
- Make sure that the ambient air is free of acids or other corrosive media.
- Do not place any objects on the gateway.
- Observe the environmental conditions according to EN 60721-3-1:
 - 1K5 for a gateway
 - 1M3 for a gateway with GSM module

5 Installation

The work described in this section is only to be performed by personnel appropriately qualified to carry out such tasks.

5.1 Installation conditions

Work position

The work position for the gateway is the front view onto the operating controls on the gateway seen from the position of operating personnel.

Operators must ensure that, after installation of the gateway, the operating personnel can perform all necessary work safely and easily access the device from the work position.

Mounting orientation

→ Mount the gateway in the upright position only:

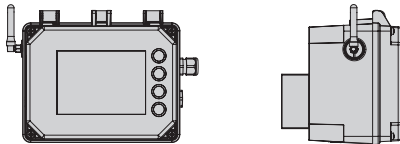

5.2 Preparation for installation

Proceed as follows:

- Check the gateway to make sure that it is clean and not damaged.
- Lay out the necessary material and tools to have them ready during installation work.

i Note

The kit for pipe mounting is available as an accessory (item no. 1402-1910)

5.3 Setting up the optional additional functions

If the option modules, GSM module and standby power supply have not already been installed when the gateway was delivered, we recommend installing them before installing the gateway.

a) Setting up before installation of the gateway

! NOTICE

Risk of damage to components for optional additional functions due to electrostatic discharge.

→ *Observe the ESD requirements according to IEC 61340-5-1.*

1. Make sure that the gateway is not yet connected to a electrical power supply.
2. Undo the five screws on the cover and remove the cover.

Installation

3. If applicable, insert an option module (see section 5.3.2).
4. If applicable, set up the standby power supply (see section 5.3.2).
5. Place on the cover and make sure that the inserted option modules are seated in the openings intended for them in the cover.
6. Fasten the cover.

b) Setting up when the gateway has already been put into service

⚠ DANGER

Risk of fatal injury due to electric shock (230 V version).

- ➔ *Before connecting wiring, performing any work on the device or opening the device, disconnect the voltage supply and protect it against unintentional reconnection.*
- ➔ *Only use power interruption devices that are protected against unintentional reconnection of the power supply.*

ⓘ NOTICE

Risk of damage to components for optional additional functions due to electrostatic discharge.

- ➔ *Observe the ESD requirements according to IEC 61340-5-1.*
-

1. Disconnect the electrical power supply from the gateway and connected modules.
2. Undo the five screws on the cover and remove the cover.
3. If applicable, insert an option module (see section 5.3.2).
4. If applicable, set up the standby power supply (see section 5.3.2).
5. Place on the cover and make sure that the inserted option modules are seated in the openings intended for them in the cover.
6. Fasten the cover.

5.3.1 Inserting option modules

i Note

When replacing an option module, remove the inserted option module as described in the 'Removal' section.

Four slots to hold option modules exist in the gateway (see Fig. 5-1).

1. Open the cover and insert the option module into one of the slots, making sure it is inserted correctly.
2. If necessary, break open the openings for the terminals in the cover (by pressing the predetermined breaking points).

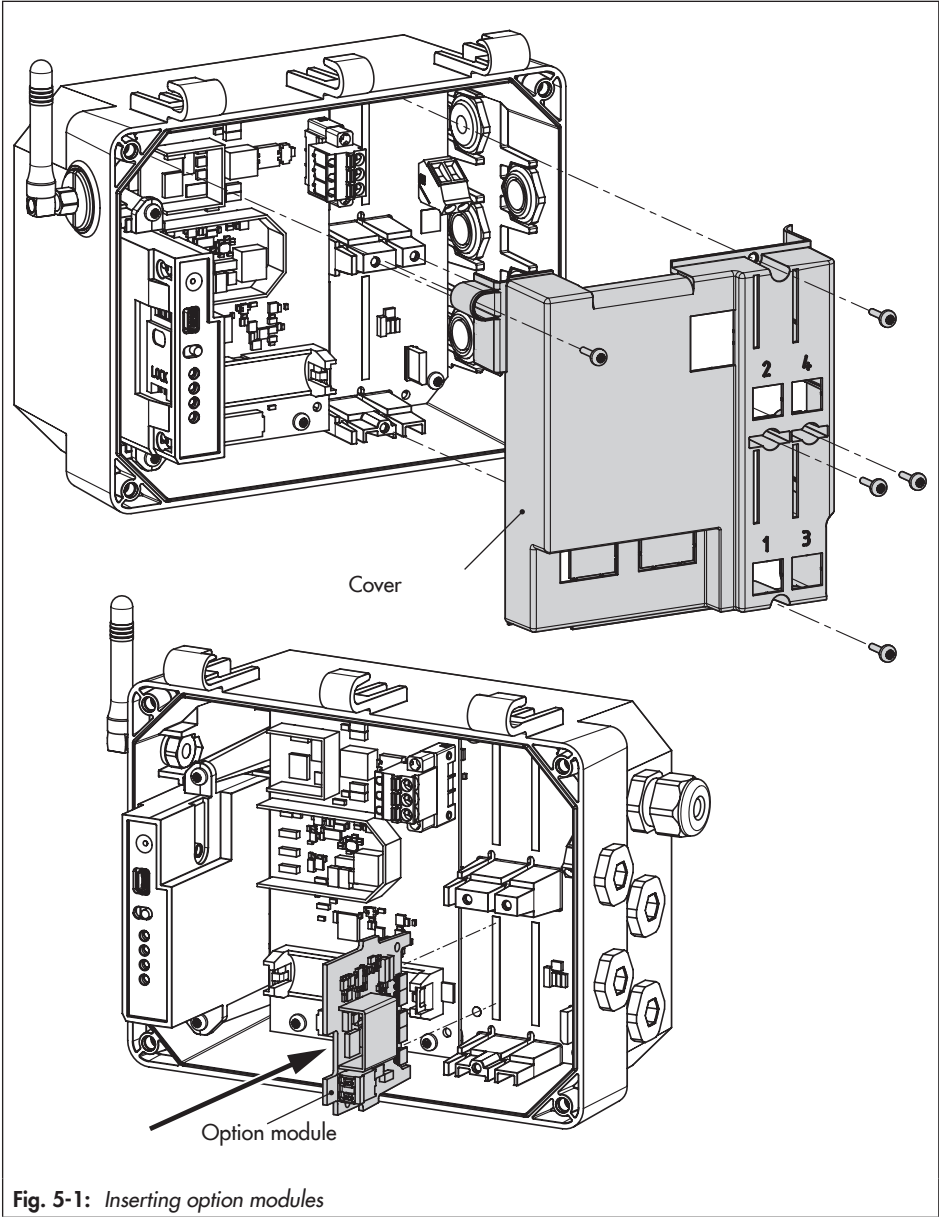

Fig. 5-1: Inserting option modules

5.3.2 Setting up the standby power supply (SPS)

i Note

The battery is not included in the scope of delivery.

Operation with standby power supply (SPS) is restricted as follows:

- The **GSM module** does not function in SPS mode.
 - The **AIA: Analog input active option module** does not supply any voltage.
-

! NOTICE

The use of unapproved batteries will damage the gateway.

- Do not use rechargeable batteries in the gateway.
-

💡 Tip

The standby power supply can also be used during the first start-up when no other power supply is available. A lithium battery allows the device to run for approx. seven days.

To continue to supply the power supply unit with power after a power failure, we recommend using a battery with the following specifications:

- AA lithium battery (mignon), 1.5 V
- Industrial battery with long service life (min. 3000 mAh recommended)
- Suitable for temperatures from -40 to +60 °C

Inserting the battery

1. Place the 1.5 V battery in the battery compartment (see Fig. 5-2)
- **Observe the correct polarity.** A battery symbol with plus and minus signs on the battery compartment indicates the polarity.

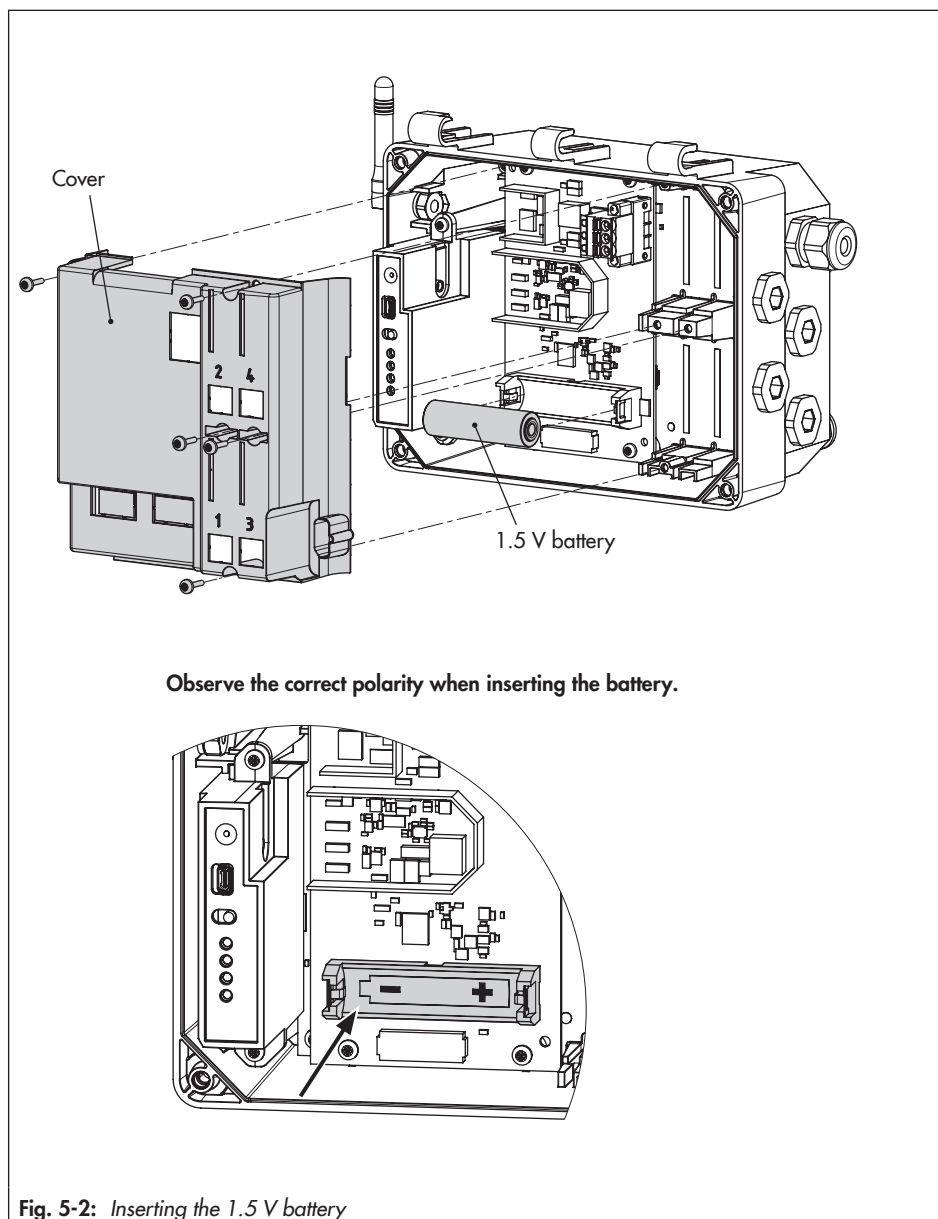

5.4 Mounting the SAM Connect Gateway

The following options to mount the gateway in the plant are available:

- 4x M8 tapped holes on the back (see Fig. 5-3 for hole pattern)
- Kit for pipe mounting as accessory (see Fig. 5-4)

Additional points that apply concerning installation:

- Observe mounting position.
- Mount the device free of vibration.
- Use mounting part with clamp for pipe mounting to attach it to a vertical or horizontal pipe.

5.5 Establishing electrical connections

⚠ DANGER

Risk of fatal injury due to electric shock (230 V version).

- *Before connecting wiring, performing any work on the device or opening the device, disconnect the voltage supply and protect it against unintentional re-connection.*
 - *Only use power interruption devices that are protected against unintentional re-connection of the power supply.*
 - *Upon installation of the electric cables, you are required to observe the regulations concerning low-voltage installations according to DIN VDE 0100 as well as the regulations of your local power supplier.*
 - *Use a suitable voltage supply which guarantees that no dangerous voltages reach the device in normal operation or in the event of a fault in the system or any other system parts.*
-

ⓘ NOTICE

Risk of damage to the electronics due to the incorrect connection of the electrical power supply.

- *Observe the permissible tolerances of the supply voltage.*
 - *For wiring, you are required to observe the relevant regulations concerning device safety and electromagnetic compatibility.*
-

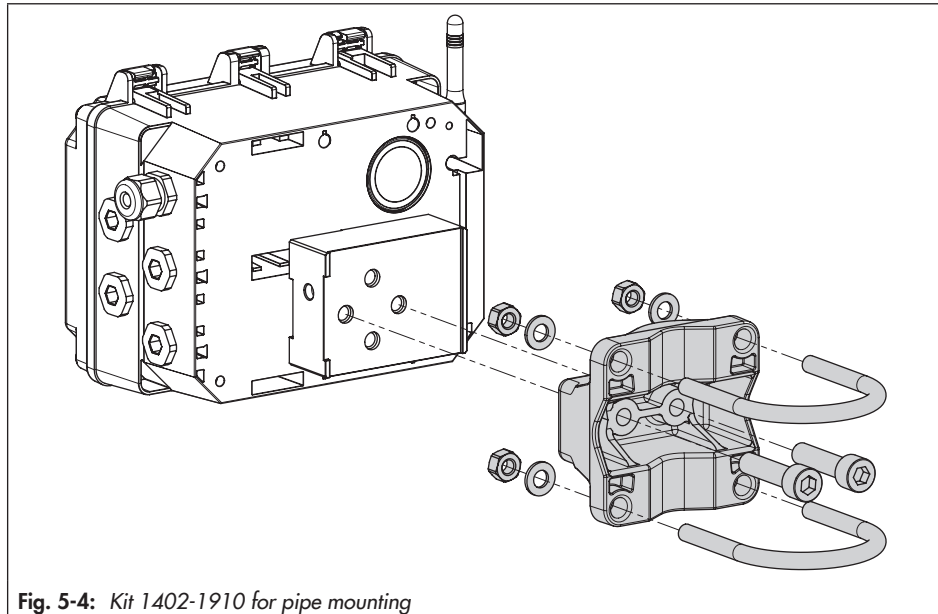
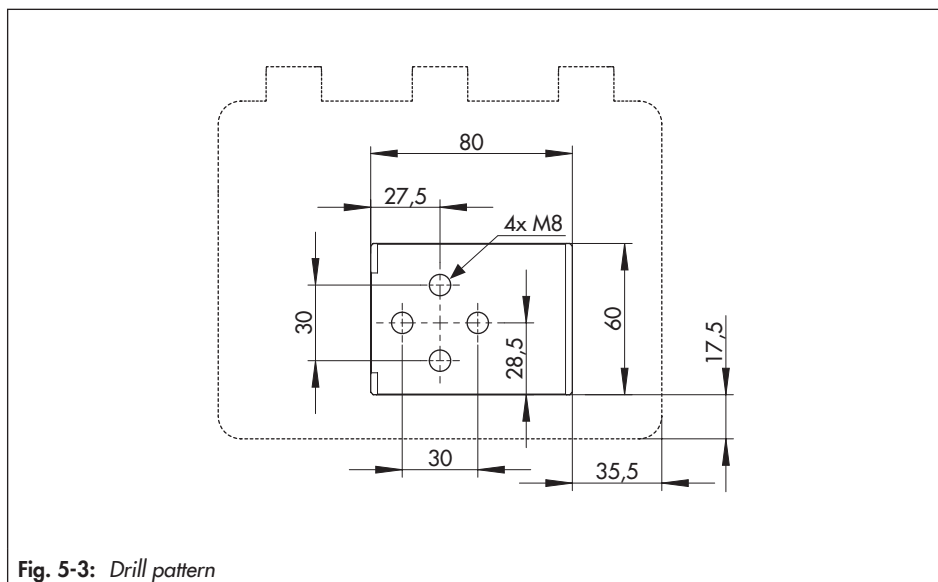

Installation

Selecting cables and wires

- Use cable glands with M16x1.5 thread whose diameter and shape have been approved by the manufacturer for the cable used.
- Seal cable entries left unused with plugs.
- The cable entry used must correspond with the ambient temperature range and have the specified IP rating (see technical data in the 'Design and principle of operation' section).

Cable glands and terminals

The housing of the gateway has five threaded boreholes, which can be fitted with cable glands as required.

- The cable gland version depends on the ambient temperature range (see technical data in the 'Design and principle of operation' section).
- The cage clamp terminals hold wire cross-sections of 0.2 to 2.5 mm².

Electrical connection



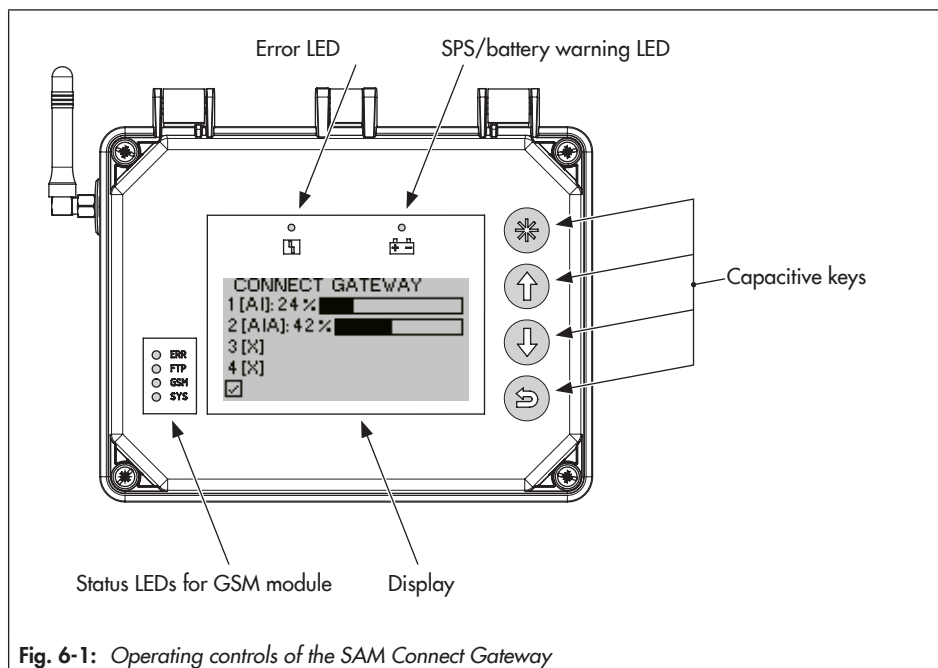

- Connect the wiring as shown in Fig. 5-5.
- Insert the wire without force.
- To remove the wire, use a slotted screwdriver to press the unlocking slot of the cage clamp terminal and remove the wire.
- Route the grounding connection (PE) to the corresponding terminal.
- Set the local power line frequency (see the 'Start-up' section).

6 Operation



6.1 Capacitive keys

The capacitive keys for on-site operation are located to the right of the display.

-  Confirm, select, change
-  Scroll upward, increase value
-  Scroll downward, reduce value
-  Back

6.2 Display

As soon as the supply voltage is connected, an overview of option modules is shown on first start-up or, in all other cases, the start screen (see Fig. 6-2).

Press  key (in start screen) to go to the main menu. Settings can be made and process values read in the main menu. The 'Start-up' section contains a description of the basic start-up settings. A list of parameters for on-site operation is included in Annex A (configuration instructions).

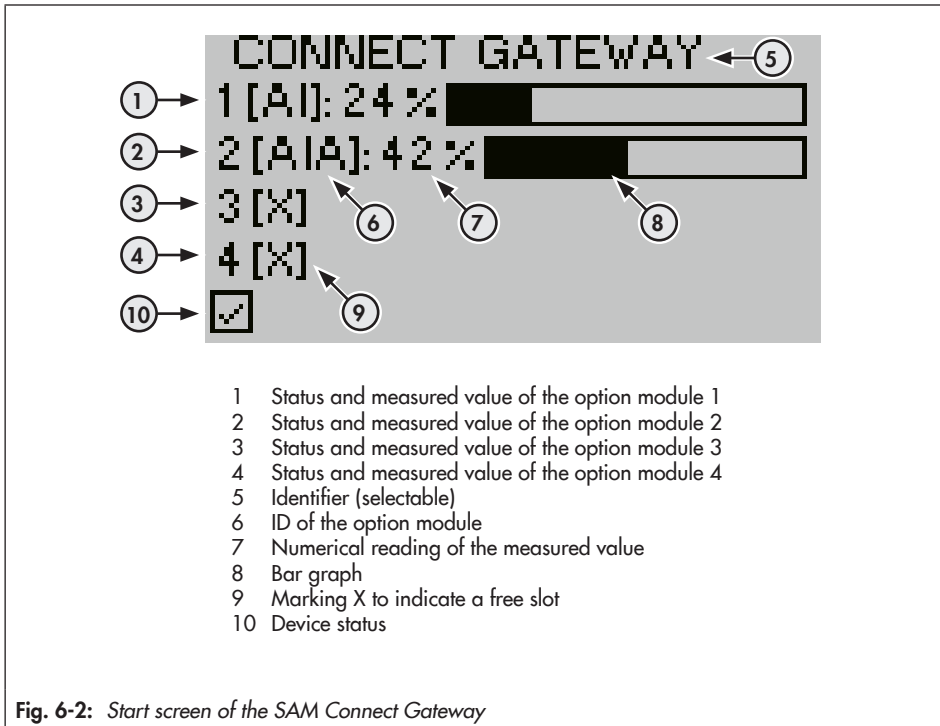

Fig. 6-2: Start screen of the SAM Connect Gateway

7 Start-up and configuration

The work described in this section is only to be performed by personnel appropriately qualified to carry out such tasks.

Once the mounting and start-up activities have been completed, you can start with the settings. The gateway is ready for operation as soon as the supply voltage is connected.

First start-up

When the gateway is started up for the first time after delivery, an overview of the option modules appears on the display after connecting the supply voltage. The option module wizard can be started when this overview is shown.

Note

- The language is set to English by default on first start-up.
 - If no settings are entered within five minutes, the display returns to the start screen.
-



Tip

We recommend proceeding as follows during first start-up:

1. Start the option module wizard.
 2. Set user level (see section 7.1.1).
 3. Enter the local power line frequency (see section 7.1.4).
 4. Perform the settings of the option module (see section 7.1.5).
-

On first start-up of the gateway, an overview of the option modules appears on the display. The option module wizard can be started when this overview is shown.

The overview of the option modules shows the slots for the option modules.

1. Press  or  key to select the required slot or option module.
 2. Press  key to confirm the setting.
- ➔ Depending on the selected option module, diverse settings, such as name, signal source, limit etc., can be made. Descriptions to the parameters can be found in the parameter list in Annex A (configuration instructions) for the corresponding option modules from menu item 2.2 onwards.

i Note











- Select **ESC** to exit the option module wizard at any time.
 - Select **forward** (>) and **back** (<) to navigate between steps.
 - The option module wizard can be started from the Device settings (2) menu/Option modules (2.2)/Overview of option modules (2.2.1 and 2.2.1.1) by selecting a slot/option module ('Specialist' user level only).
 - If no settings are entered within five minutes, the display returns to the start screen.
-

7.1 Settings

7.1.1 Setting the user level

The gateway has two user levels with different access privileges:

- **Maintenance staff:** values and parameters can be selected and read in this user level. Changes are not possible in this level.
- **Specialist:** all values can be accessed and parameters changed in this user level. This user level can be password-protected to prevent unauthorized access.











1. Press  key (in start screen) to go to the main menu.
2. Select Start-up (1) with  or  key and confirm with  key.
3. Select User level (1.1) with  or  key and confirm with  key.
4. Press  key and select 'Specialist' with  or  key.
5. Press  key to confirm the setting.

7.1.2 Setting the language

The following languages are available for selection in the language menu of the gateway:



















- English · German · French · Italian · Spanish

The language can only be changed in the **Specialist** user level.

1. Press  key (in start screen) to go to the main menu.
2. Select Start-up (1) with  or  key and confirm with  key.
3. Select Sprache/Language (1.2) with  or  key and confirm with  key.
4. Press  key and select the required language with  or  key.
5. Press  key to confirm the setting.

7.1.3 Activating password protection







The password can only be changed and activated in the Specialist user level.

1. Press  key (in start screen) to go to the main menu.
 2. Select Start-up (1) with  or  key and confirm with  key.
 3. Select password protection (1.3) with  or  key.
 4. Press  key to activate password protection.
- ➔ The default password is **1234**. To change the password, proceed as follows:
1. In the Start-up (1) menu, select Password (1.4) with  or  key and confirm with  key.
 2. Press  key. Select the digit within the password with  or  key.
 3. Press  key. Change the number (0 to 9) within the password with  or  key.
 4. Confirm with  key (proceed in the same way for the rest of the password).
 5. After selecting all digits of the password, press  key.

7.1.4 Setting the local power line frequency

The local power line frequency must be entered to be able to properly filter out any disturbances which are transmitted over ground wires or external power supply units. The default power line frequency is 50 Hz.











The power line frequency can only be changed in the **Specialist** user level.

1. Press  key (in start screen) to go to the main menu.
2. Select Start-up (1) with  or  key and confirm with  key.
3. Select power line frequency (1.6) with  or  key.
4. Press  key to change the setting (50 Hz or 60 Hz).

7.1.5 Performing option module settings

The settings of the option module parameters can be performed in the option module wizard or the device settings.

The option module parameters can only be changed in the **Specialist** user level.

1. Press  key (in start screen) to go to the main menu.
2. Select Device settings (2) with  or  key and confirm with  key.
3. Select option modules (2.2) with  or  key and confirm with  key.
4. Select the required slot (2.2.2 to 2.2.5) with  or  key and confirm with  key.
5. Perform settings: the parameters are listed in the Annex A (configuration instructions).

8 Operation

The work described in this section is only to be performed by personnel appropriately qualified to carry out such tasks.

8.1 Remote data transmission

i Note

The remote data transmission can only be used when a GSM module is installed.

To use remote data transmission, SAMSON creates a user account for each customer in the SAM TANK MANAGEMENT web interface. All devices are added to the account by SAMSON.

➔ Contact SAMSON's After-sales Service for details on how to register in SAM TANK MANAGEMENT.

8.1.1 Status LEDs of the GSM module

Table 8-1 below describes the meaning of the LEDs.

8.1.2 Improving the signal quality

The signal strength can be indicated by the LEDs on the GSM module. Proceed as follows:

1. Press the service key on the GSM module and hold for three seconds (see Fig. 8-1).
2. The LEDs indicate the signal strength. Values in Table 8-2 apply.

Aligning the antenna

Move the antenna to the upright position for the best reception results. If a weather guard or other housing parts are located directly above the device due to the mounting situation, tilt the antenna slightly (see Fig. 8-2).

i Note





If the signal is poor in the location where the device is installed, an external mobile network antenna with SMA connection (commonly available mobile network accessories) can be used.

Operation

Table 8-1: LEDs and their meaning

LED	Color	Illuminated	Blinks
ERR	Red	Error or failure	2x: GSM module without SIM card 3x: incorrect PIN
FTP	Green		Fast blinking: data transmission in progress
GSM	Green	Searching for a network	1x: GSM connection OK 2x: server connection OK 3x: PIN code failed 4x: hardware error Fast blinking: incoming SMS text message
SYS	Green		1x: system ON

Table 8-2: Signal strength reading

Reading	CSQ value ¹⁾	Signal quality
Red LED 	< 8 (< -96 dBm)	No signal
Red LED + 1 x green LED 	< 15 (< -82 dBm)	Poor quality
Red LED + 2x green LEDs 	< 21 (< -70 dBm)	Fair quality
Red LED + 3x green LEDs 	≥ 21 (≥ -70 dBm)	Good quality

¹⁾ CSQ (Cell Signal Quality), parameter to indicate the signal strength (signal quality) in mobile networks

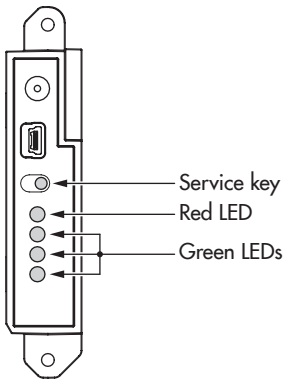

Fig. 8-1: Signal strength indication

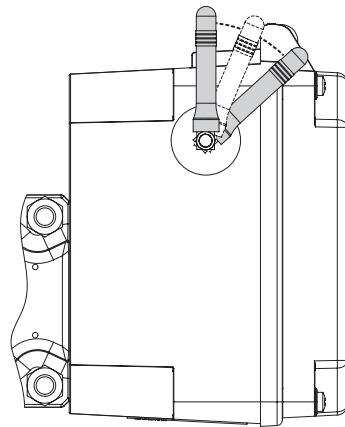

Fig. 8-2: Aligning the antenna

9 Malfunctions





The work described in this section is only to be performed by personnel appropriately qualified to carry out such tasks.

⚠ DANGER

Risk of fatal injury due to electric shock (230 V version).

- Before connecting wiring, performing any work on the device or opening the device, disconnect the voltage supply and protect it against unintentional re-connection.
- Only use power interruption devices that are protected against unintentional re-connection of the power supply.

Table 9-1: Icon showing status classification

Status icon	Priority	Meaning
	1	Failure: the gateway cannot perform its task due to a malfunction.
	2	Out of specification: the gateway is running outside the specified operating conditions..
	3	Maintenance required: the gateway still performs its task (with restrictions). A maintenance demand has been determined.
	4	No message: the gateway perform its task without any impairment.

9.1 Troubleshooting

Malfunctions are indicated on the display by error messages in conjunction with an icon for status classification and an error ID. The meaning of the icons and their order of priority are listed in Table 9-1.

On the start screen, error messages can be cleared by pressing the  key. Error messages and recommended action for troubleshooting are listed in Table 9-2.

Malfunctions

Table 9-2: *Troubleshooting*

Error ID	Message	Possible causes and recommended action
103	Memory error (calibration)	<p>The gateway has an internal device error.</p> <p>→ Contact SAMSON's After-sales Service.</p>
104	Memory error (data)	
105	No factory calibration	
107	Internal data processing error	
205	Temperature inside device below min. limit	<p>The temperature limit inside the device has fallen below the adjusted min. limit.</p> <p>→ Check whether the heating functions properly and the heating control is switched on.</p> <p>→ Select lower temperature limit.</p>
206	Temperature inside device above max. limit	<p>The temperature limit inside the device has exceeded the adjusted max. limit.</p> <p>→ Check whether the heating functions properly and the heating control is switched on.</p> <p>→ Select a better location to mount the device, if necessary.</p>
301	Power supply unit not recognized	<p>The current firmware of the device does not support the supply voltage. A firmware update is necessary.</p> <p>→ Contact SAMSON's After-sales Service.</p>
302	Option not recognized	<p>The current firmware of the device does not support the option. A firmware update is necessary. The option is defective.</p> <p>→ Contact SAMSON's After-sales Service.</p>

10 Servicing

The work described in this section is only to be performed by personnel appropriately qualified to carry out such tasks.

⚠ DANGER

Risk of fatal injury due to electric shock (230 V version).

- *Before connecting wiring, performing any work on the device or opening the device, disconnect the voltage supply and protect it against unintentional re-connection.*
- *Only use power interruption devices that are protected against unintentional re-connection of the power supply.*

i Note

The gateway was checked by SAMSON before it left the factory.

- *The product warranty becomes void if service or repair work not described in these instructions is performed without prior agreement by SAMSON's After-sales Service.*
- *Only use original spare parts by SAMSON, which comply with the original specifications.*

10.1 Firmware updates

Contact your local SAMSON engineering and sales office or subsidiary to request a firmware update. SAMSON subsidiaries are listed on our website at

▶ www.samsongroup.com (*About SAMSON > Sales offices*).

Required specifications

Please submit the following details on requesting a firmware update:

- Type
- Serial number
- Configuration ID
- Current firmware version
- Required firmware version

10.2 Periodic inspection and testing of the gateway

We recommend inspection and testing according to Table 10-1 at the minimum.

Table 10-1: *Recommended inspection and testing*

Inspection and testing	Action to be taken in the event of a negative result
Check the markings, labels and nameplates on the gateway for their readability and completeness.	Contact SAMSON when nameplates or labels are damaged, missing or incorrect to renew them.
	Clean any inscriptions that are covered with dirt and are illegible.
Check the gateway to ensure it is mounted firmly.	Tighten the any loose mounting screws.
Check the power lines.	Tighten any loose cable glands.
	Make sure that the stranded wires are pushed into the terminals and tighten any loose screws on the the terminals.
	Renew damaged lines.
Check error messages on the display (indicated by the ⊗, ⚠, ⚡ and ✓ icons).	Troubleshooting (see the 'Malfunctions' section).

11 Decommissioning

The work described in this section is only to be performed by personnel appropriately qualified to carry out such tasks.

DANGER

Risk of fatal injury due to electric shock (230 V version).

- *Before connecting wiring, performing any work on the device or opening the device, disconnect the voltage supply and protect it against unintentional re-connection.*
 - *Only use power interruption devices that are protected against unintentional re-connection of the power supply.*
-

To decommission the gateway before removing it, proceed as follows:

1. Disconnect the power supply.
2. Open the housing cover of the gateway and disconnect the wires for the power supply.

12 Removal

The work described in this section is only to be performed by personnel appropriately qualified to carry out such tasks.

! **NOTICE**

Electrostatic discharge will damage the installed modules.

→ *Observe the ESD requirements according to IEC 61340-5-1.*

12.1 Removing the option module

1. Put the gateway out of operation (see the 'Decommissioning' section).
2. Disconnect the connecting lines on the option module.
3. Undo the five screws on the cover and remove the cover.
4. Pull the option module out of the slot and store it in its packaging.

If the gateway is to continue operating without the option module:

- Place on the cover and fasten it.
- Put the gateway back into operation (see the 'Start-up and configuration' section).

12.2 Removing the gateway

1. Put the gateway out of operation (see the 'Decommissioning' section).
2. Removing the option module
3. Disconnect the wires for the power supply from the gateway.
4. To remove the gateway, loosen the fastening screws.

13 Repairs

A defective gateway must be repaired or replaced.

! NOTICE

Risk of gateway damage due to incorrect service or repair work.

- Do not perform any repair work on your own.
- Contact SAMSON's After-sales Service for repair work.

3. Proceed as described on the Returning goods page of our website
 - ▶ www.samsongroup.com > Service & Support > After-sales Service > Returning goods

13.1 Returning devices to SAMSON

i Note

When returning gateways which are intended for measuring gaseous oxygen for repair, the sender assumes full responsibility that the devices are handled to meet all requirements stipulated by VBG 62 or similar regulations until they are handed over to the manufacturer. Otherwise, SAMSON does not accept any responsibility.

Defective gateways can be returned to SAMSON for repair.

Proceed as follows to return devices to SAMSON:

1. Put the gateway out of operation (see the 'Decommissioning' section).
2. Remove the gateway (see the 'Removal' section).

14 Disposal



We are registered with the German national register for waste electric equipment (stiftung ear) as a producer of electrical and electronic equipment, WEEE reg. no.: DE 62194439

- Do not dispose of components, lubricants and hazardous substances together with your other household waste.
- Check whether a battery is inserted in the gateway and remove it before disposing of the device.
- Observe local, national and international refuse regulations before disposing of the device and its batteries.

i Note

We can provide you with a recycling passport according to PAS 1049 on request. Simply e-mail us at aftersaleservice@samsongroup.com giving details of your company address.

Tip

On request, we can appoint a service provider to dismantle and recycle the product.

15 Certificates

The following certificates are included on the next pages:

- EU declaration of conformity for Type 5007

The certificates shown were up to date at the time of publishing. The latest certificates can be found on our website:

▶ www.samsongroup.com > Products & Applications > Product selector > Automation Systems > SAM Connect Gateway (5007-2)



EU Konformitätserklärung / EU Declaration of Conformity / Déclaration UE de conformité

Die alleinige Verantwortung für die Ausstellung dieser Konformitätserklärung trägt der Hersteller/
This declaration of conformity is issued under the sole responsibility of the manufacturer/
La présente déclaration de conformité est établie sous la seule responsabilité du fabricant.
Für das folgende Produkt / For the following product / Nous certifions que le produit

SAM Connect Gateway

Typ/Type/Type 5007-2

wird die Konformität mit den einschlägigen Harmonisierungsrechtsvorschriften der Union bestätigt /
the conformity with the relevant Union harmonisation legislation is declared with/
est conforme à la législation d'harmonisation de l'Union applicable selon les normes:

RED 2014/53/EU	EN 301489-1:V1.9.2, EN 301489-7:V1.3.1 EN 301511:V12.1.1, TS 151010-1:V12.2.0
RoHS 2011/65/EU	EN 50581:2012

Hersteller / Manufacturer / Fabricant:

SAMSON AKTIENGESELLSCHAFT
Weismüllerstraße 3
D-60314 Frankfurt am Main
Deutschland/Germany/Allemagne

Frankfurt / Francfort, 2020-09-29

Im Namen des Herstellers/ On behalf of the Manufacturer/ Au nom du fabricant.

Dipl.-Ing. Jens Bieger
Zentralabteilungsleiter/Head of Department/Chef du département
Entwicklung Ventilanbaugeräte und Messtechnik
Development Valve Attachments and Measurement Technologies

Dipl.-Ing. Silke Bianca Schäfer
Total Quality Management/
Management par la qualité totale

ce_5007-2_de_en_fra_ue03.pdf

16 Annex A (configuration instructions)

The menu structure and parameters for on-site operation are described below. Further settings can also be made in the TROVIS-VIEW software. These settings are described in the Operating Instructions (SAM Connect Gateway – Configuration with TROVIS-VIEW)

► EB 9511-2.

i Note

The availability of executed menu items and parameters depends on the version and configuration of the gateway as well as the option modules used. Default settings are marked 'default'.

Menu		Adjustment range/values/description
Start-up	1	
User level	1.1	Select user level Maintenance staff: restricted access Specialist: full access (password protection possible in menu item 1.7) ▪ Maintenance staff (default), Specialist
Sprache/Language	1.2	Select the menu and display language: ▪ English (default), Deutsch, Français, Italiano, Espanol, Türk, Русский
Start-up wizard	1.4	Run the wizard.
Password protection	1.5	Activate/deactivate write protection in the gateway by entering a four-digit code (menu item 1.4). When write protection is active, the 'Specialist' user level cannot be accessed to change parameter settings. ▪ Active, Not active (default)
Password	1.6	Enter a four-digit code for password protection ▪ 0000 to 9999 (default: 1234)
Write protection (data transmission module)	1.7	Activate/deactivate remote write protection to protect the gateway against unauthorized remote access. ▪ Active, Not active (default)
Power line frequency	1.6	Local power line frequency to filter out any disturbances which are transmitted over ground wires or external power supply units. ▪ 50 Hz (default), 60 Hz

Annex A (configuration instructions)

Menu	Adjustment range/values/description	
Device settings	2	
General	2.1	
Identifier	2.1.1	Enter a freely selectable name for the device (max. 15 characters) ▪ Enter characters as required (default: CONNECT GATEWAY)
LCD backlight	2.1.2	Activate or deactivate LCD backlight ▪ ON, OFF (default)
LCD deactivation time	2.1.3	Activate/deactivate the deactivation time for the LCD backlight. ▪ ON, OFF (default)
Deactivation time	2.1.4	Enter the time after which the LCD is to be automatically switched off. ▪ 1 to 10 min (default: 10 min) Parameter only shown when 'LCD deactivation time' = ON.
LCD heating control	2.1.5	Activate/deactivate the heating of the display at low outdoor temperatures: Upper switching temperature (deactivate): -12.5 °C Lower switching temperature (activate): -17.5 °C The power consumption of the device increases by 510 mA when the heating is activated. ▪ ON (default), OFF
User level timeout	2.1.6	Time setting after which the on-site operation is to be locked if no settings are entered (user level at the device returns from 'Specialist' to 'Maintenance staff', locking of on-site operation) ▪ 0 to 60 min (default: 15 min)
Option 1 display	2.1.7	Setting for the value reading on the start screen for option module 1 ▪ Bar graph (default), Numerical
Option 2 display	2.1.8	Setting for the value reading on the start screen for option module 2 ▪ Bar graph (default), Numerical
Option 3 display	2.1.9	Setting for the value reading on the start screen for option module 3 ▪ Bar graph (default), Numerical
Option 4 display	2.1.10	Setting for the value reading on the start screen for option module 4 ▪ Bar graph (default), Numerical

Menu		Adjustment range/values/description
Option modules	2.2	
Overview of option modules	2.2.1	
	2.2.1.0	Overview of option modules in four slots as graph, starts option module wizard
Slot 1	2.2.2	<i>The available parameters of inserted options modules are listed depending on the optional additional function.</i>
Slot 2	2.2.3	
Slot 3	2.2.4	
Slot 4	2.2.5	
AI: Analog input/AIA: Analog input active		
Option module identification1	Reading to indicate that an optional additional function has been detected.
Option module status2	Reading of the current status of the option module <ul style="list-style-type: none"> ▪ No module inserted, Module not permissible in this setup, Module unknown, Module active
Name3	Enter a name (max. 15 characters) for identification <ul style="list-style-type: none"> ▪ Enter characters as required (default: OPTION)
Signal source4	Enter the signal source on which the 4 to 20 mA signal is based <ul style="list-style-type: none"> ▪ Unknown (default), liquid level, pressure, temperature
Medium identifier5	Enter a name (max. 15 characters) to identify the medium. The parameter is only visible when the signal source is set to <i>filling level</i> . <ul style="list-style-type: none"> ▪ Enter characters as required (default: MEDIUM)
Measured value6	Reading of the current measured value in the selected unit
Unit7	Unit in which the measured value is to be indicated. <ul style="list-style-type: none"> ▪ % (default), kg, Nm³, L, ft³, lbs, mbar, bar, kPa, psi, mmH₂O, cmH₂O, mH₂O, inH₂O, °C, °F, K
Lower measuring range value8	Determine the lower limit of the measuring range at 4 mA <ul style="list-style-type: none"> ▪ Enter value as required (depending on the selected unit)
Upper measuring range value9	Determine the upper limit of the measuring range at 20 mA <ul style="list-style-type: none"> ▪ Enter value as required (depending on the selected unit)









Annex A (configuration instructions)

Menu	Adjustment range/values/description
Event: Broken cable10	Activates or deactivates the event for a detected cable breakage at the input of the AI option module. The event is activated when the signal falls below the switching threshold of 0.2 mA. ▪ ON (default), OFF
Event: Residual current11	Activates or deactivates the event for a detected residual current violation at the input of the AI option module. The event is activated when the signal falls below the switching threshold of 3.6 mA or exceeds 21.0 mA. ▪ ON (default), OFF
Limit 112	Activate/deactivate limit 1 ▪ ON (default), OFF
Mode13	An upper limit can be determined with 'Max. contact' and a lower limit with 'Min. contact' for limit 1. ▪ Max. contact (default), Min. contact
Limit14	Setting of limit 1 (depends on selected unit) ▪ 0.0 to 100.0 (default: 90.0) Parameter only shown when 'Signal source' = 'Pressure' or 'Temperature'.
Limit15	Setting of limit 1 (depends on selected unit) ▪ 0.0 to 100.0 (default: 90.0) Parameter only shown when 'Signal source' = 'Unknown' or 'Filling level'.
Limit 216	Activate/deactivate limit 2 ▪ ON (default), OFF
Mode17	An upper limit can be determined with 'Max. contact' and a lower limit with 'Min. contact' for limit 2. ▪ Max. contact, Min. contact (default)
Limit18	Setting of limit 2 (depends on selected unit) ▪ 0.0 to 100.0 (default: 90.0) Parameter only shown when 'Signal source' = 'Pressure' or 'Temperature'.
Limit19	Setting of limit 2 (depends on selected unit) ▪ 0.0 to 100.0 (default: 90.0) Parameter only shown when 'Signal source' = 'Unknown' or 'Filling level'.

Menu		Adjustment range/values/description
Limit 320	Activate/deactivate limit 3 ▪ ON (default), OFF
Mode21	An upper limit can be determined with 'Max. contact' and a lower limit with 'Min. contact' for limit 3. ▪ Max. contact, Min. contact (default)
Limit22	Setting of limit 3 (depends on selected unit) ▪ 0.0 to 100.0 (default: 90.0) Parameter only shown when 'Signal source' = 'Pressure' or 'Temperature'.
Limit23	Setting of limit 3 (depends on selected unit) ▪ 0.0 to 100.0 (default: 90.0) Parameter only shown when 'Signal source' = 'Unknown' or 'Filling level'.
4 to 20 mA measured value24	Reading of the current (in mA) at the option module
Relative measured value25	Reading of the current (in %) at the option module
Start test26	Executable function to test a signal reading in the device and over the web portal. The input signal of the option module is replaced by an internal test signal and issued by the GSM module.
Test mode27	Test mode reading: 'Active' while the test is in progress (test duration: 30 s). ▪ Not active (default), Active
Analog input test signal28	Test signals (depending on the selected unit) based on the 4 to 20 mA signal range. ▪ -214748364.7 to 214748364.7 (default: 0)

Annex A (configuration instructions)

Menu		Adjustment range/values/description
Zero point29	<p>The zero correction allows the input value to be corrected by $\pm 10\%$ at the maximum. The zero correction is always performed before the span correction. The following functions are available:</p> <ul style="list-style-type: none"> – Set zero: zero is set to the current input value (e.g. 3 %) and the measured value is set to 0 %. – Reset zero: zero is set to 0 %. <ul style="list-style-type: none"> ▪ Set zero (default), reset zero <p>The following values are displayed:</p> <ul style="list-style-type: none"> – Measured value (analog input signal) in % – Currently adjusted zero – Measured value (analog input signal) in mA
Span30	<p>The span correction allows the input value to be corrected by $\pm 20\%$ at the maximum. Always perform a zero correction before the span correction. The following functions are available:</p> <ul style="list-style-type: none"> – Set span: span is set to the current input value (e.g. 103 %) and the measured value is set to 100 %. – Reset span: span is set to 0 %. <ul style="list-style-type: none"> ▪ Set span (default), reset span <p>The following values are displayed:</p> <ul style="list-style-type: none"> – Measured value (analog input signal) in % – Currently adjusted span – Measured value (analog input signal) in mA
Zero shift31	Zero shift reading in %
Span offset32	Span offset reading in %
Identification	2.3	
Firmware version	2.3.1	Read the current firmware version of the SAM Connect Gateway
Serial number of the entire device	2.3.2	Read the serial number of the SAM Connect Gateway
Serial number of option 1	2.3.3	Reading of the serial number of the option module in slot 1
Serial number of option 2	2.3.4	Reading of the serial number of the option module in slot 2
Serial number of option 3	2.3.5	Reading of the serial number of the option module in slot 3
Serial number of option 4	2.3.6	Reading of the serial number of the option module in slot 4
HW version/supply voltage	2.3.7	Reading of the hardware version of the voltage supply

Menu		Adjustment range/values/description			
Explosion protection certification	2.3.8	Indicates whether the SAM Connect Gateway has explosion protection approval ▪ No (the SAM Connect Gateway does not have any explosion protection certificates).			
Process data		3			
Temperature inside device	3.1	Read the current device temperature in °C			
Heating	3.2	Indicates the state of the heating (on/off)			
Battery voltage	3.3	Battery voltage reading in V			
Diagnostics		4			
Status messages	4.1	Status messages provide an overview on the current states of individual functions or components of the gateway. A corresponding status icon is assigned to failures and error messages:  Failure (error class E1)  Out of specification (error class E2)  Maintenance required (error class E3)  No message			
	Possible status				
Condensed state	4.1.1	•	•	•	•
Condensed state (E1)	4.1.2	•			•
103: Memory (calibration)	4.1.3	•			•
104: Memory (data)	4.1.4	•			•
105: Factory calibration	4.1.5	•			•
107: Data processing	4.1.6	•			•
Condensed state (E2)	4.1.7		•		•
205: Min. temperature	4.1.8		•		•
206: Max. temperature	4.1.9		•		•
Condensed state (E3)	4.1.10		•		•
301: Power supply unit	4.1.11			•	•
302: Option not recognized	4.1.12			•	•
Dagnostic data		4.2			

Annex A (configuration instructions)

Menu		Adjustment range/values/description
Operation duration	4.2.1	Reading of the entire operating time of the device (dd:hh:m-m:ss)
Temperature events		4.3
Max. temperature limit	4.3.1	Activate/deactivate the temperature monitoring with limit for max. temperature inside the device <ul style="list-style-type: none">▪ ON, OFF (default)
Limit	4.3.2	Set an upper temperature limit within the specified range: if the current device temperature is above the adjusted limit, an error message is generated and displayed. The status changes to 'Out of specification'. <ul style="list-style-type: none">▪ 10 to 70 °C (default: 60 °C)
Min. temperature limit	4.3.3	Activate/deactivate the temperature monitoring with limit for min. temperature inside the device <ul style="list-style-type: none">▪ ON, OFF (default)
Limit	4.3.4	Set a lower temperature limit within the specified range: if the current device temperature is below the adjusted limit, an error message is generated and displayed. The status changes to 'Out of specification'. <ul style="list-style-type: none">▪ -40 to +10 °C (default: -15 °C)

17 Annex B

17.1 Accessories

A list of available accessories for the Media Series can be found in the Data Sheet

▶ T 9555.

17.2 After-sales service

Contact our after-sales service for support concerning service or repair work or when malfunctions or defects arise.

You can reach our after-sales service at aftersalesservice@samsongroup.com.

Addresses of SAMSON AG and its subsidiaries

The addresses of SAMSON AG, its subsidiaries, representatives and service facilities worldwide can be found on our website (www.samsongroup.com) or in all SAMSON product catalogs.

Required specifications

Please submit the following details:

- Order number and position number in the order
- Type, serial number, firmware version, device version

EB 9511 EN



SAMSON AKTIENGESELLSCHAFT
Weismüllerstraße 3 · 60314 Frankfurt am Main, Germany
Phone: +49 69 4009-0 · Fax: +49 69 4009-1507
samson@samsongroup.com · www.samsongroup.com